

6-GFM(G)-75Ah

Gel Battery Specification

Application

- Maintenance free
- Safety and no leakage
- Excellent recharge and discharge performance
- Low self-discharge rate
- Adapt to high or low temperature
- Good deep discharge performance
- Longer cycle life



Specification

Rated Voltage	12V
Numbers of cells	6 Cells
Capacity	75Ah@20hr-rate to 1.75V per cell @25°C
Weight	23.5kg
Internal Resistance	Approx. 7 mΩ
Terminal	F15(M6) / F11(M6)
Max. Discharge Current	750A(5s)
Max. Charging Current	15A
Reference Capacity	C3 51.0AH C5 59.0AH C10 65.8AH C20 75.0AH
Design Life	10~15 years
Float Charging Voltage	13.6 V~13.8 V @ 25°C Temperature Compensation: -20mV/°C/Cell
Cycle Use Voltage	14.4 V~14.9 V @ 25°C Temperature Compensation: -30mV/°C/Cell
Operating Temperature Range	Discharge: -40°C~60°C Charge: -20°C~50°C Storage: -40°C~60°C
Normal Operating Temperature Range	25°C±5°C
Self Discharge	Less than 3% at 25°C per month
Container Material	A.B.S. UL94-HB, UL94-V0 Optional.

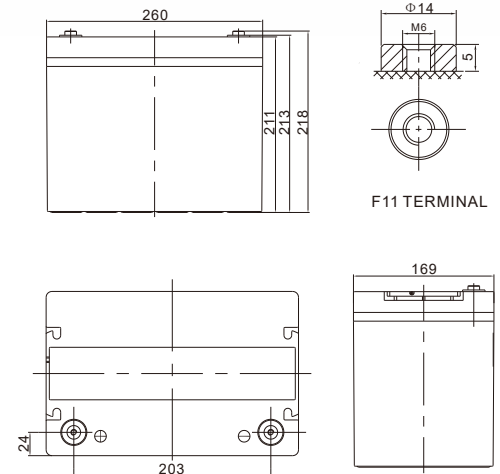

Length	260±1mm (10.2 inches)
Width	169±1mm (6.65 inches)
Height	211±1mm (8.31 inches)
Total Height	218±1mm (8.58 inches)

Constant Current Discharge Characteristics: A[25°C]

F.V/Time	10MIN	15MIN	30MIN	1HR	2HR	3HR	4HR	5HR	8HR	10HR	20HR
1.60V/cell	139.0	108.8	71.5	41.9	25.1	17.3	14.3	12.1	8.25	6.84	4.13
1.65V/cell	132.3	106.5	70.3	41.7	24.9	17.2	14.3	12.0	8.18	6.78	3.98
1.70V/cell	127.6	104.9	69.7	41.3	24.7	17.1	14.2	11.9	8.11	6.71	3.86
1.75V/cell	119.1	101.0	69.9	41.0	24.5	17.0	14.1	11.8	8.05	6.64	3.75
1.80V/cell	109.9	94.2	69.3	40.0	24.1	16.6	13.7	11.6	7.91	6.58	3.53
1.85V/cell	99.4	85.5	65.5	38.0	23.0	15.9	13.1	11.1	7.58	6.38	3.38

Constant Power Discharge Characteristics: WPC[25°C]

F.V/Time	10MIN	15MIN	30MIN	1HR	2HR	3HR	4HR	5HR	8HR	10HR	20HR
1.60V/cell	247	198	134	80.7	49.3	34.3	28.5	24.0	16.4	13.6	7.29
1.65V/cell	239	194	132	80.5	49.0	34.4	28.5	23.9	16.3	13.5	7.17
1.70V/cell	233	192	133	79.9	48.7	34.2	28.4	23.9	16.2	13.4	7.04
1.75V/cell	219	186	133	79.2	48.3	34.1	28.1	23.6	16.1	13.3	6.90
1.80V/cell	205	174	132	77.7	47.7	33.1	27.5	23.2	15.8	13.2	6.77
1.85V/cell	187	158	126	74.4	46.0	31.7	26.2	22.2	15.2	12.8	6.37

6-GFM(G)-75Ah

Gel Battery Specification

Charge Characteristics for Float Use @ 25°C/77°F

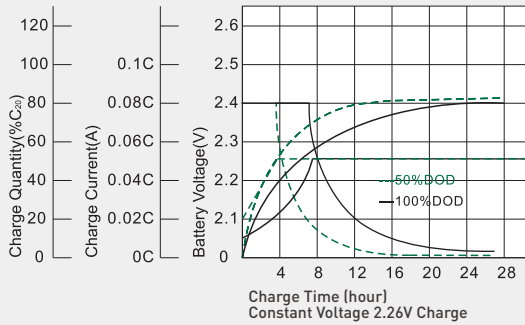

Discharge Characteristics at Various Rates @ 25°C/77°F

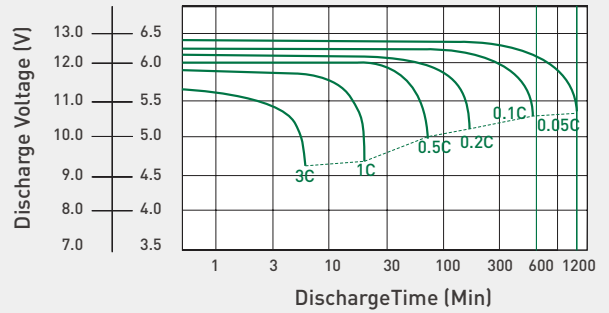

Cycle Life in Relation to Depth of Discharge

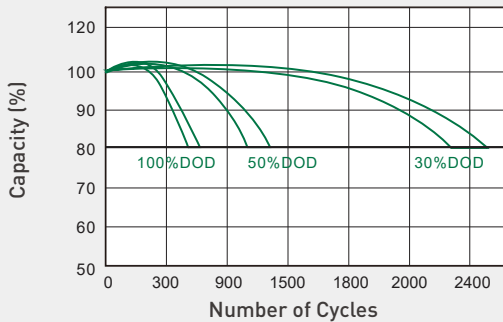

Float Service Life

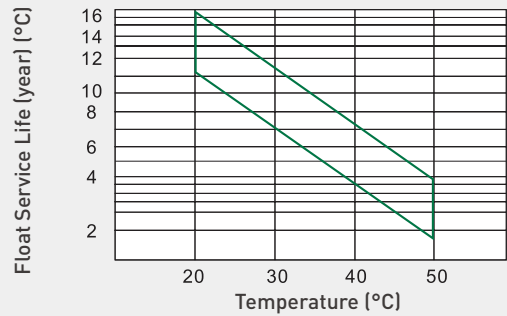

Temperature and Valid Capacity

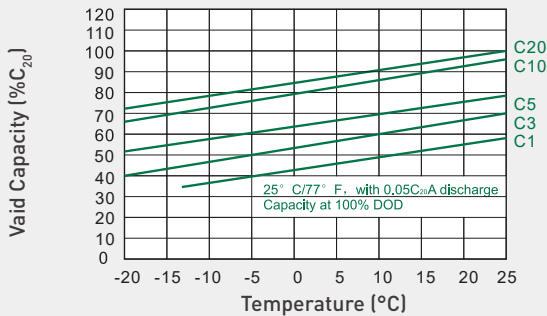

Self Discharge Characteristics

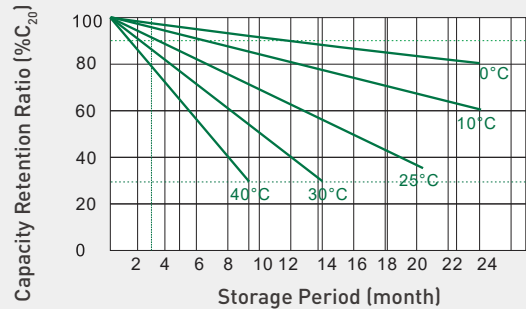

Capacity and Open Circuit Voltage

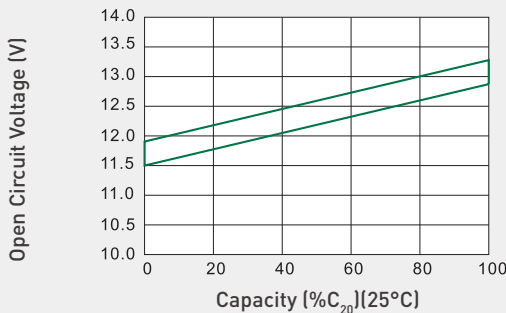

Relationship between Charging Voltage and Temperature

